

ASSEMBLY INSTRUCTIONS - 050 - SW - HU - 2 - (2' SLATWALL H-UNIT)

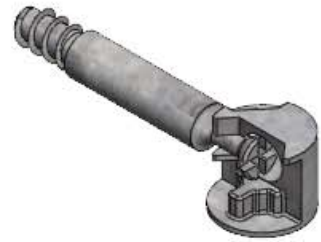

CAMLOCK (X32)

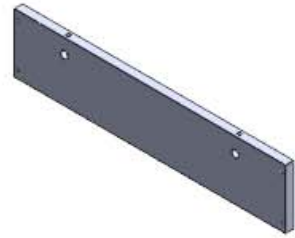

A. TOE KICK PANEL - A (X2)

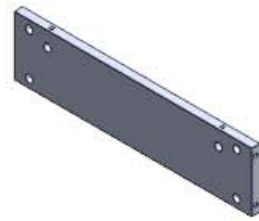

B. TOE KICK PANEL - B (X2)

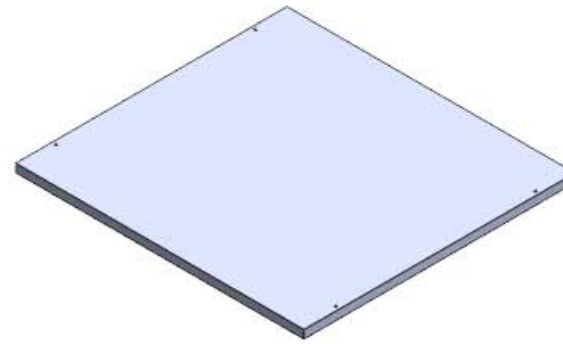

C. BOTTOM PANEL (X1)



D. CENTER SLATWALL (X1)

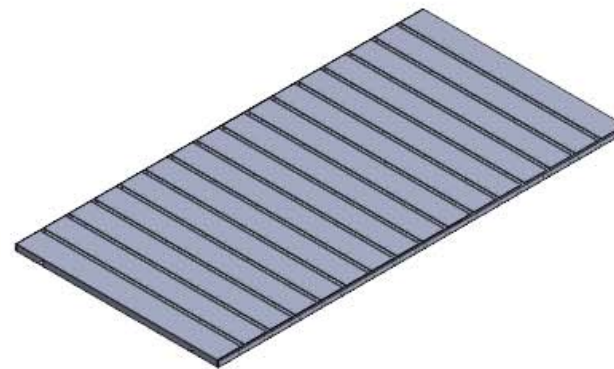

E. SIDE SLATWALL (X2)

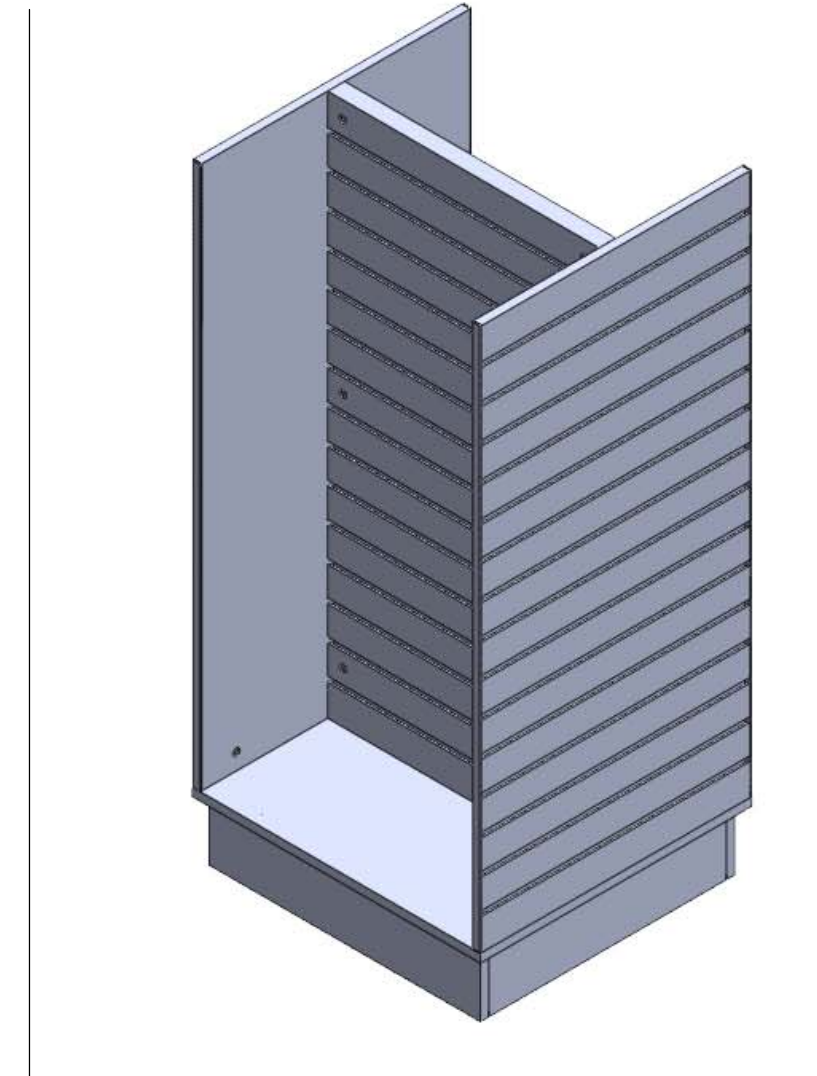

ASSEMBLY INSTRUCTIONS - 050 - SW - HU - 2 - (2' SLATWALL H-UNIT)

STEP 1:

1. INSERT THE BOLTS OF CAMLOCK INTO TOE KICK PANEL - A;
2. CONNECT TOE KICK PANEL - A & B BY CAMLOCKS;

TOE KICK PANEL - A (X2)
TOE KICK PANEL - B (X2)
CAMLOCK (X8)

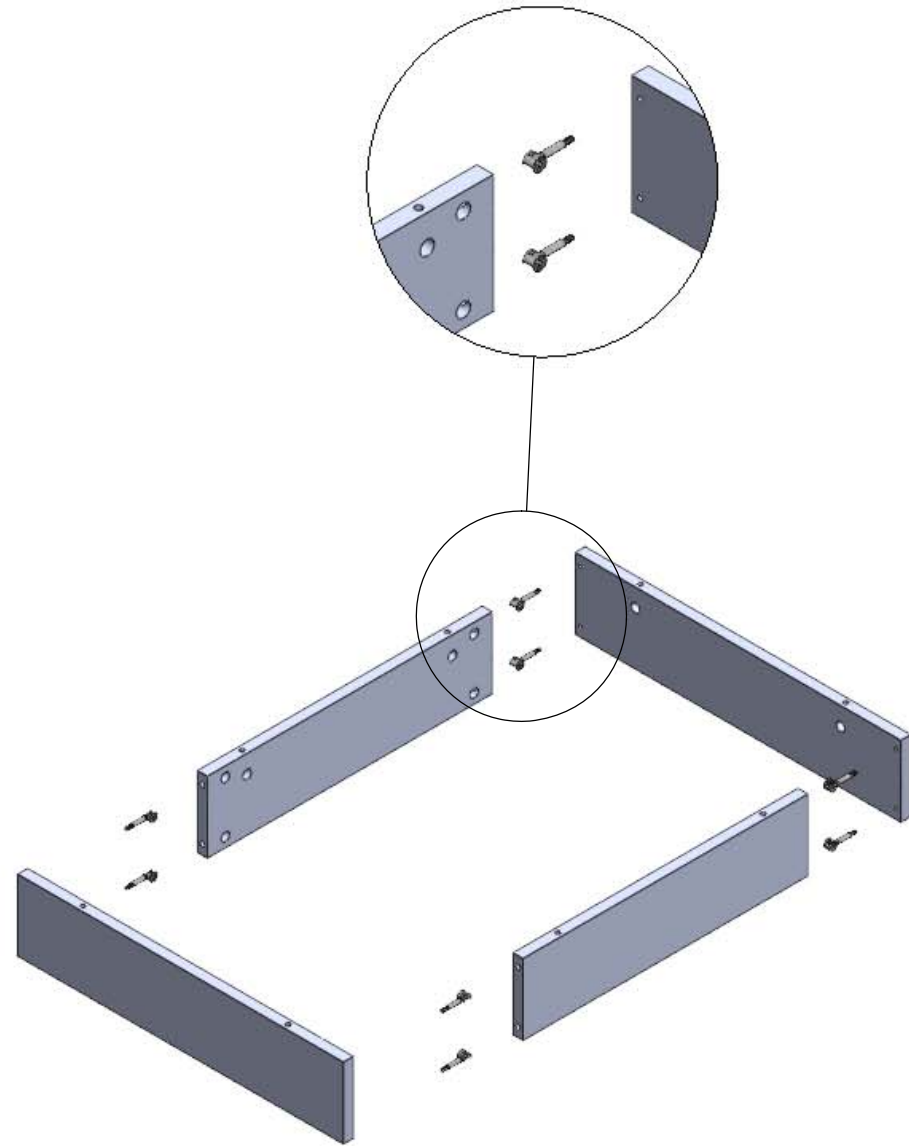

STEP 2:

1. INSERT THE BOLTS OF CAMLOCK INTO SIDE SLATWALL;
2. CONNECT SIDE SLATWALL & CENTER SLATWALL BY CAMLOCKS;

CENTER SLATWALL (X1)
SIDE SLATWALL (X2)
CAMLOCK (X12)

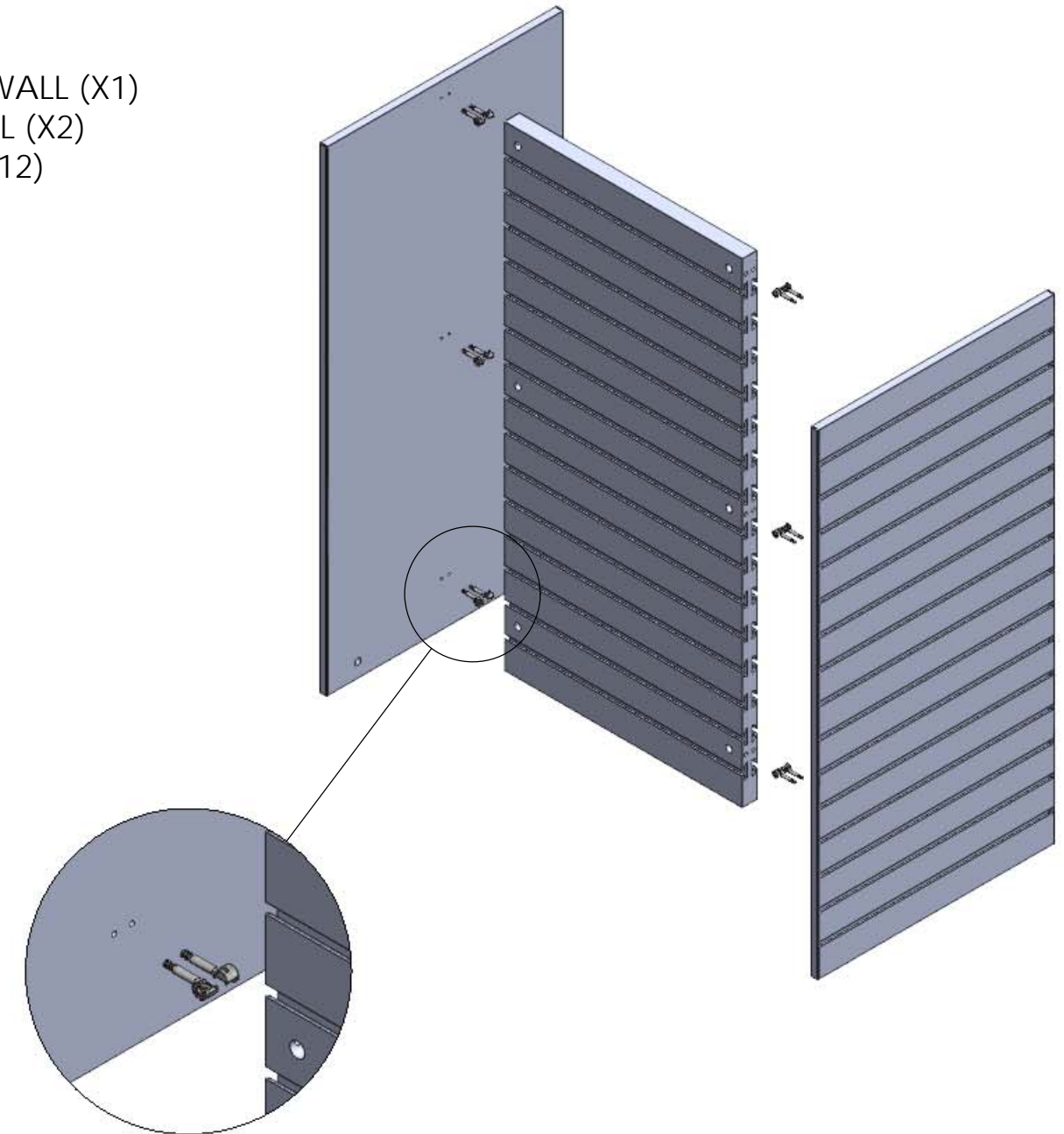

ASSEMBLY INSTRUCTIONS - 050 - SW - HU - 2 - (2' SLATWALL H-UNIT)

STEP 3:

1. ATTACH BOTTOM PANEL TO SLATWALL ASSEMBLED BY CAMLOCKS;

SLATWALL ASSEMBLED (X1)
BOTTOM PANEL (X1)
CAMLOCK (X4)

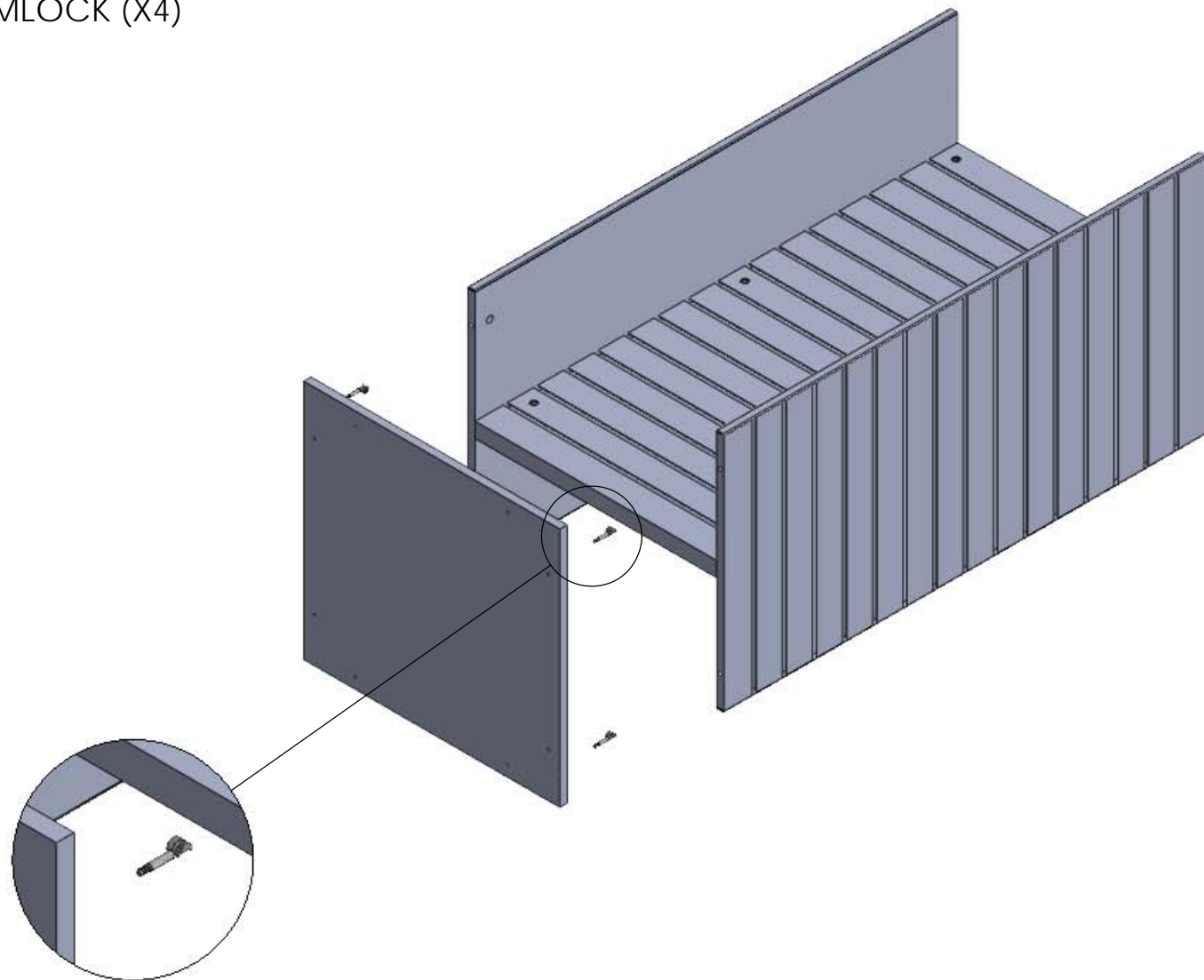

STEP 4:

1. ATTACH TOE KICK ASSEMBLED BY CAMLOCKS;

TOE KICK ASSEMBLED (X1)
CAMLOCK (X8)

